



CorePro LED PLC 4P

CorePro LED PLC 9W 840 4P G24q-3

The CorePro LED PLC 4P integrates a LED light source into a traditional fluorescent form factor. This product is the ideal solution for uplamping in general lighting applications: it meets basic lighting requirements, offers significant energy savings and is environmentally friendly.

Product data

General Information		Warm-up time to 60% light (nom.)	
Cap base	G24Q-3 [G24q-3]		0.5 s
EU RoHS compliant	Yes	Power factor (nom.)	0.9
Nominal lifetime (nom.)	30000 h	Voltage (Nom)	20-50 V
Switching cycle	50,000X	Temperature	
Light Technical		T-ambient (max.)	35 °C
Colour Code	840 [CCT of 4,000 K]	T-ambient (min.)	-20 °C
Beam Angle (Nom)	120 °	T storage (max.)	65 °C
Luminous flux (nom.)	1000 lm	T storage (min.)	-40 °C
Colour designation	Cool White (CW)	T-Case maximum (nom.)	76 °C
Correlated Colour Temperature (Nom)	4000 K	Controls and Dimming	
Luminous efficacy (rated) (nom.)	100.00 lm/W	Dimmable	No
Colour consistency	<6	Mechanical and Housing	
Colour rendering index (nom.)	83	Product length	200 mm
LLMF at end of nominal lifetime (nom.)	70 %	Approval and Application	
Operating and Electrical		Energy efficiency label (EEL)	A+
Input frequency	30000-80000 Hz	Energy-saving product	Yes
Power (Rated) (Nom)	9 W	Approval marks	CE marking RoHS compliance KEMA Keur certificate
Lamp current (max.)	400 mA		
Lamp current (min.)	250 mA		
Starting time (nom.)	0.5 s		

CorePro LED PLC 4P

Energy consumption kWh/1,000 hours	12 kWh
Product Data	
Full product code	871869654117300
Order product name	CorePro LED PLC 9W 840 4P G24q-3
EAN/UPC – product	8718696541173
Order code	54117300

Numerator – quantity per pack	1
SAP numerator – packs per outer box	10
Material no. (12 NC)	929001200902
Net Weight (Piece)	0.088 kg

Dimensional drawing

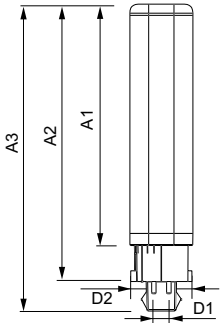

LEDtube PLC 9W G24q-3/840 4P

Product	D1	D2	A1	A2	A3
CorePro LED PLC 9W 840 4P G24q-3	24.3 mm	28.4 mm	128.8 mm	148 mm	163.6 mm

Photometric data

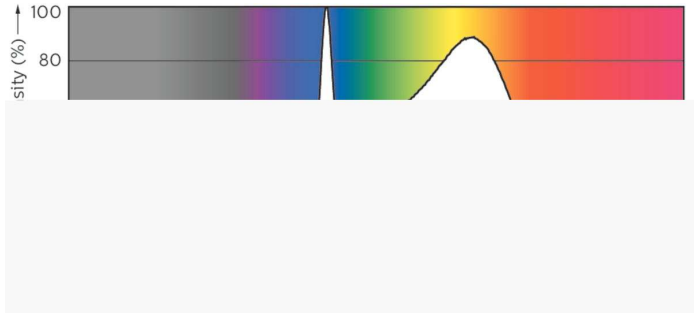
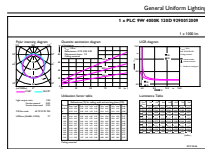

LEDtube PLC 100mm 9W G24Q-3 840 1000lm

LEDtube PLC 100mm 9W G24Q-3 840 1000lm

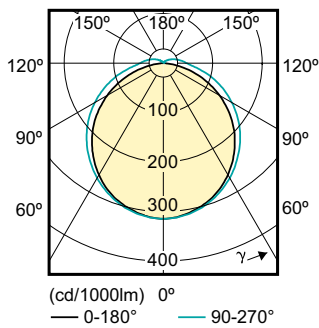

CorePro LED PLC 4P

Lifetime

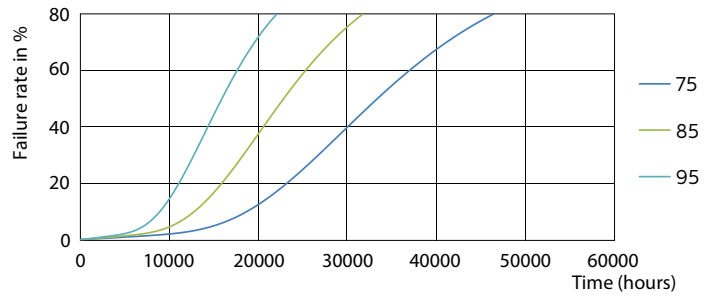
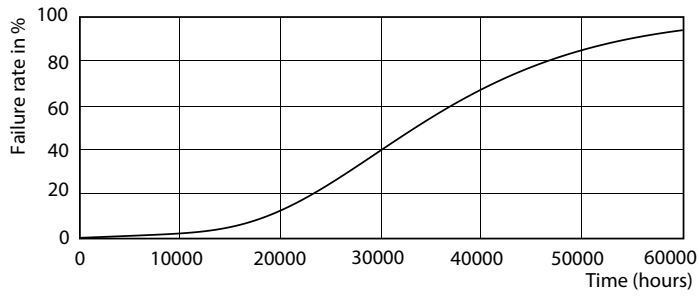

LEDtube PLC 100mm 9W G24Q-3 830 950lm

LEDtube PLC 100mm 9W G24Q-3 830 950lm

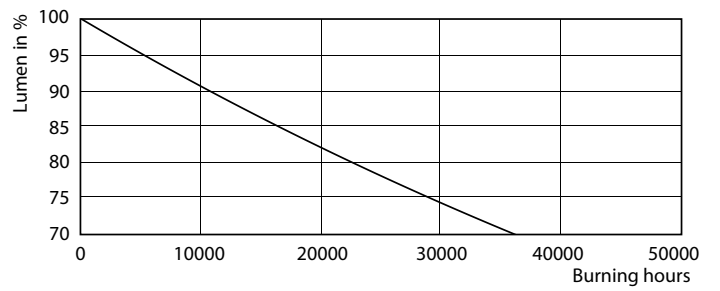
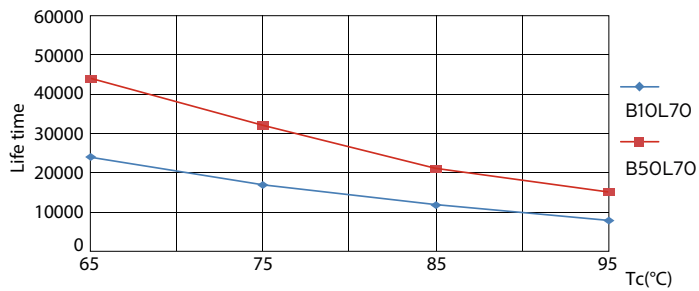

LEDtube PLC 100mm 9W G24Q-3 830 950lm

LEDtube PLC 100mm 9W G24Q-3 830 950lm

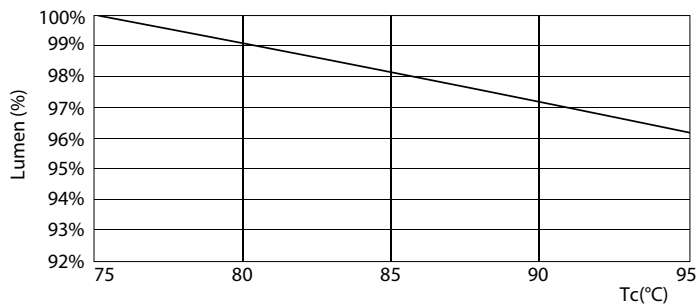

LEDtube PLC 100mm 9W G24Q-3 830 950lm

